

Article number: 206532M419ST
Description: E+G knurled screw
GN 653.2-M4-19-ST

Measures

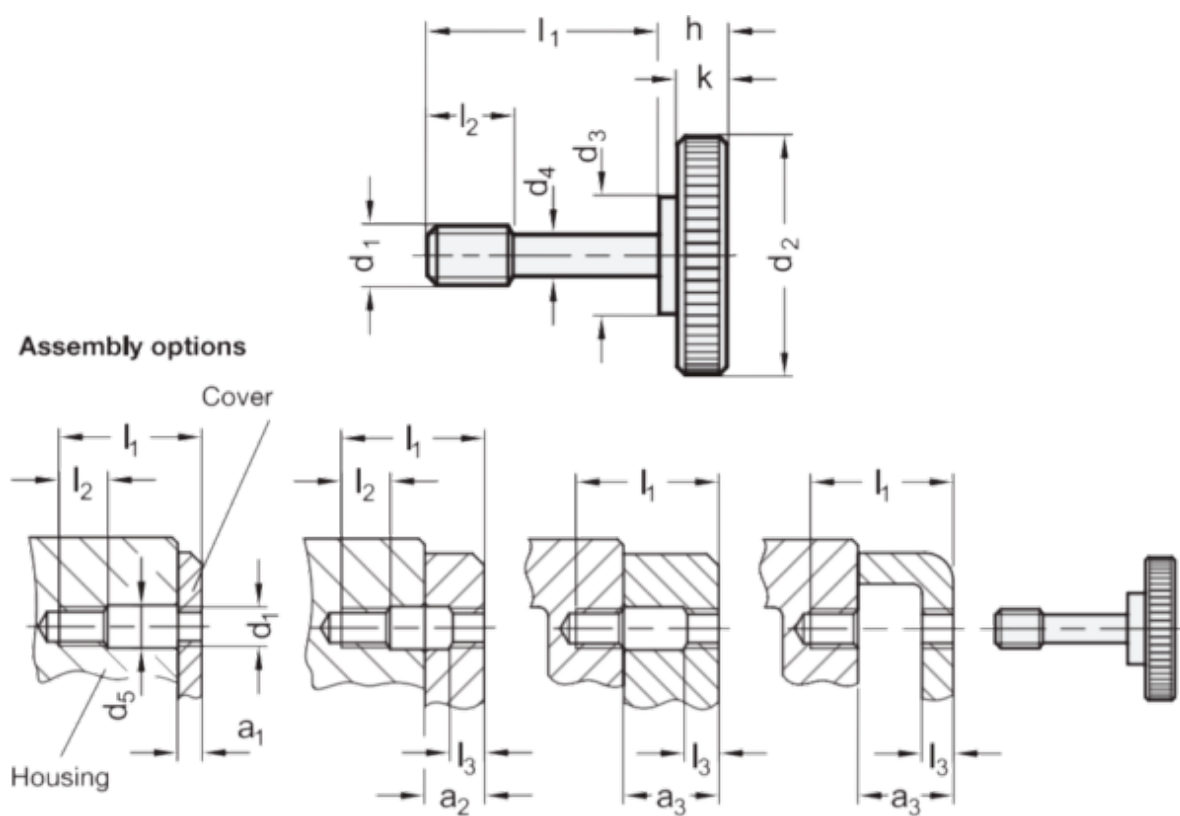

$d_1 = M4$
 $d_2 = 16$
 $d_3 = 8$
 $d_4 = 3.2$
 $h = 5.5$
 $k = 3.5$
 $l_1 = 19$